

ENGINE DRIVEN BEARING BRACKET

SEAL KIT : SK05

ITEMS NOT SHOWN :

1. ITEMS 19 & 22 ARE LIP SEAL SLEEVES FOR SHAFT REPAIR.
2. ITEM 20 SEAL BONDED RUBBER FOR MECH SEAL OIL CHAMBER DRAIN PLUG.

PARTS CONTAINED IN SEAL KIT ARE NOT RETURNABLE. WHEN ORDERING INDIVIDUAL SPARE PUMP PARTS, PLEASE DO NOT USE THE NUMBERS ON THIS SHEET.

THESE NUMBERS ARE FOR SEAL KIT REFERENCE ONLY - PLEASE REFER TO THE PARTS BREAKDOWN FOR THE UNIT. PLEASE BE AWARE THAT ALL LARGE DIAMETER GASKETS/SHIMS ARE ALSO CONTAINED AT THE BOTTOM OF THIS PACKAGING BOX.

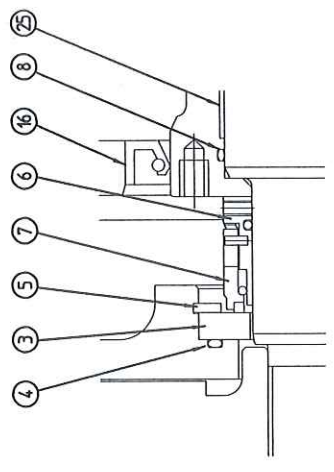

MECHANICAL SEAL ASSEMBLY

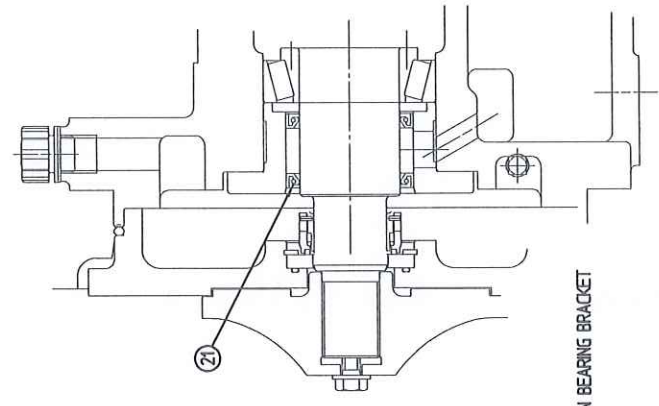

ELECTRIC MOTOR DRIVEN BEARING BRACKET

Pos	Qty	PartNo	Description
25	1	141-0241-6112	TOLERANCE RING
22	1	138-1767-6112	LIP SEAL SLEEVE
21	2	138-0809-4112	LIP SEAL
20	1	143-0733-9912	SEAL BONDED RUBBER
19	1	138-1751-6112	LIP SEAL SLEEVE
18	1	135-0301-6172	PLAIN WASHER
17	1	135-0330-3618	SCREW HEX HEAD STIFF
16	1	138-1033-4112	LIP SEAL
15	1	138-1034-5543	GASKET
14	1	138-1034-5533	GASKET
13	1	138-1034-5523	GASKET
12	1	138-1034-5513	GASKET
11	1	136-0646-6533	SHIM IMPELLER
10	1	136-0646-6523	SHIM IMPELLER
9	1	136-0646-6513	SHIM IMPELLER
8	1	138-1036-1112	O RING
7	1	138-1446-9912	SEAL FACE
6	1	138-1445-9912	MECHANICAL SEAL
5	1	141-0586-9911	CIRCLIP
4	1	138-0700-1112	O RING
3	1	138-0620-9913	SEAL SEAT
2	1	138-1004-1112	O RING
1	10	143-1947-9912	SEAL BONDED RUBBER
			SK05

ITEM 25 ADDED

IF IN DOUBT - ASK
DO NOT SCALE

Osborn, Stewart - Xylem
WED OCT 21 15

THIRD ANGLE PROJECTION
TPS TO BS 8888:2013

Osborn, Stewart - Xylem
WED OCT 21 15

SK05 M
MITSUBISHI KIT
O-RING, ENGLER SETS

Proprietary and Confidential

Item 4
38-0700-1112

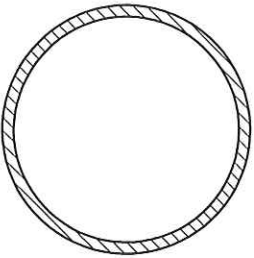

Item 6
38-1445-9912

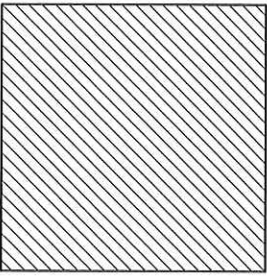

Item 3
38-0620-9913

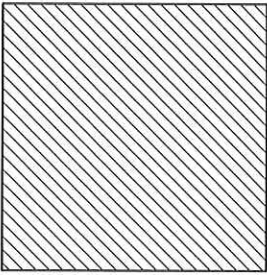

Item 7
38-1446-9912

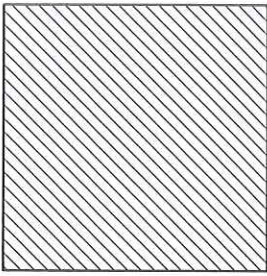

Item 8
38-1036-1112

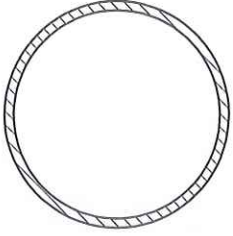

Item 5
41-0586-9911

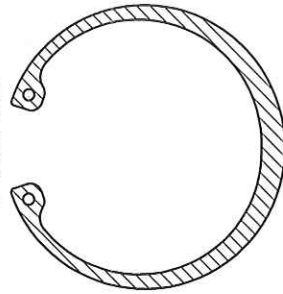

Item 19
38-1751-6112

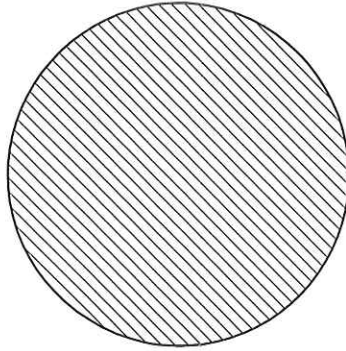

Item 2
38-1004-1112

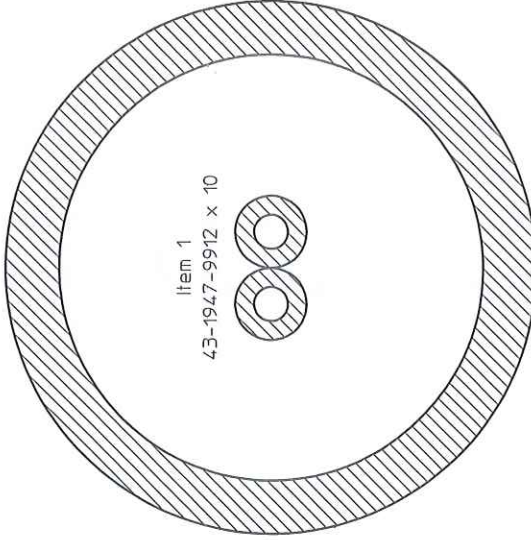

Item 9, 10 & 11
36-0646-6513
36-0646-6523
36-0646-6533

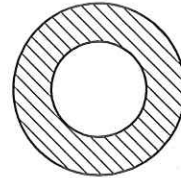

Item 20
43-0733-9912

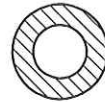

Item 22
38-1767-6112

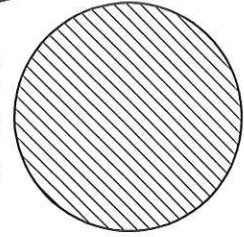

Item 17
35-0330-3618

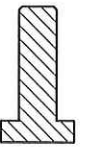

Item 18
35-0301-6172



Item 21
38-0809-4112 x 2

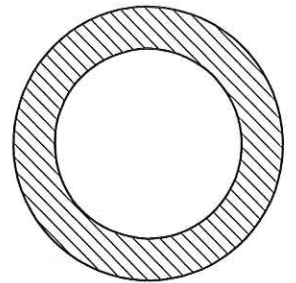

Item 16
38-1033-4112

