



www.FGWilson.com

P50-1S



Image for illustration purposes only.

Output Ratings

Generating Set Model	Prime*	Standby*
220-240V, 50 Hz	45.0 kVA / 45.0 kW	50.0 kVA / 50.0 kW
240/120V, 60 Hz	50.0 kVA / 50.0 kW	55.0 kVA / 55.0 kW

Ratings at 1.0 power factor.

Prime Rating

These ratings are applicable for supplying continuous electrical power (at variable load) in lieu of commercially purchased power. There is no limitation to the annual hours of operation and this model can supply 10% overload power for 1 hour in 12 hours.

Standby Rating

These ratings are applicable for supplying continuous electrical power (at variable load) in the event of a utility power failure. No overload is permitted on these ratings. The alternator on this model is peak continuous rated (as defined in ISO 8528-3).

Standard Reference Conditions

Note: Standard reference conditions 25°C (77°F) Air Inlet Temp, 100m (328 ft) A.S.L. 30% relative humidity.
Fuel consumption data at full load with diesel fuel with specific gravity of 0.85 and conforming to BS2869: 1998, Class A2.

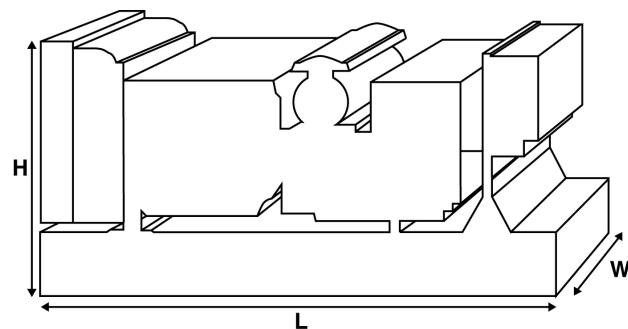

Ratings and Performance Data

Engine Make & Model:	Perkins 1103A-33TG2	
Alternator manufactured for FG Wilson by:	Leroy Somer	
Alternator Model:	LL2014J	
Control Panel:	1002T	
Base Frame:	Fbc2 - (08Hr)	
Circuit Breaker Type:	3 Pole MCCB	
Frequency:	50 Hz	60 Hz
Engine Speed: RPM	1500	1800
Fuel Tank Capacity:	219 (57.9)	
litres (US gal)		
Fuel Consumption: l/hr (US gal/hr)		
(100% Load)	Prime	13.8 (3.6) 15.8 (4.2)
	Standby	15.6 (4.1) 17.7 (4.7)

Available Options

- I CE Certification
- I Sound Attenuated EC Enclosures
- I Control Panel Upgrades
- I Range of Silencers
- I Range of Remote Fuel Systems
- I Range of Alarms and Shutdowns

Dimensions and Weights

Length (L) mm (in)	Width (W) mm (in)	Height (H) mm (in)	Dry kg (lb)	Wet kg (lb)
1925 (75.8)	1120 (44.1)	1361 (53.6)	1007 (2220)	1020 (2249)
Dry = With Lube Oil		Wet = With Lube Oil and Coolant		

Ratings in accordance with ISO 8528, ISO 3046, IEC 60034, BS5000 and NEMA MG-1/22. Generating set pictured may include optional accessories.

FG Wilson has manufacturing facilities in the following locations:

Northern Ireland • Brazil • China • India • USA

With headquarters in Northern Ireland, FG Wilson operates through a Global Dealer Network.

To contact your local Sales Office please visit the FG Wilson website at www.FGWilson.com

Engine Technical Data		
No. of Cylinders / Alignment:	3 / In Line	
Cycle:	4 Stroke	
Bore / Stroke: mm (in)	105.0 (4.1)/127.0 (5.0)	
Induction:	Turbocharged	
Cooling Method:	Water	
Governing Type:	Mechanical	
Governing Class:	ISO 8528 G2	
Compression Ratio:	17.25:1	
Displacement: l (cu. in)	3.3 (201.4)	
Moment of Inertia: kg m ² (lb/in ²)	1.14 (3896)	
Engine Electrical System:		
- Voltage / Ground	12/Negative	
- Battery Charger Amps	65	
Weight: kg (lb)	- Dry	420 (926)
	- Wet	438 (966)

Performance	50 Hz	60 Hz
Engine Speed: rpm	1500	1800
Gross Engine Power: kW (hp)		
- Prime	55.0 (74.0)	63.3 (85.0)
- Standby	60.5 (81.0)	69.6 (93.0)
BMEP: kPa (psi)		
- Prime	1333.0 (193.4)	1279.0 (185.5)
- Standby	1467.0 (212.8)	1407.0 (204.0)

Fuel System					
Fuel Filter Type:	Replaceable Element				
Recommended Fuel:	Class A2 Diesel				
Fuel Consumption: l/hr (US gal/hr)					
	110%	100%	75%	50%	
Prime	Load	Load	Load	Load	
50 Hz	15.6 (4.1)	13.8 (3.6)	10.2 (2.7)	7.1 (1.9)	
60 Hz	17.7 (4.7)	15.8 (4.2)	11.8 (3.1)	8.6 (2.3)	
	110%	100%	75%	50%	
Standby	Load	Load	Load	Load	
50 Hz		15.6 (4.1)	11.3 (3.0)	7.8 (2.1)	
60 Hz		17.7 (4.7)	12.1 (3.2)	9.2 (2.4)	

(Based on diesel fuel with a specific gravity of 0.84 and conforming to BS2869, Class A2)

Air Systems	50 Hz	60 Hz
Air Filter Type:	Replaceable Element	
Combustion Air Flow: m ³ /min (cfm)		
- Prime	3.8 (134)	4.7 (166)
- Standby	3.9 (138)	4.9 (173)
Max. Combustion Air Intake Restriction: kPa (in H ₂ O)		
	8.0 (32.1)	8.0 (32.1)

Cooling System	50 Hz	60 Hz	
Cooling System Capacity: l (US gal)	10.2 (2.7)	10.2 (2.7)	
Water Pump Type: Centrifugal			
Heat Rejected to Water & Lube Oil:			
kW (Btu/min)	- Prime	35.2 (2002)	41.0 (2332)
	- Standby	37.7 (2144)	42.8 (2434)
Heat Radiation to Room: Heat radiated from engine and alternator			
kW (Btu/min)	- Prime	10.0 (569)	11.0 (626)
	- Standby	11.0 (626)	12.0 (682)
Radiator Fan Load: kW (hp)	1.0 (1.3)	1.7 (2.3)	
Radiator Cooling Airflow: m ³ /min (cfm)	110.4 (3899)	145.8 (5149)	
External Restriction to Cooling Airflow: Pa (in H ₂ O)			
	120 (0.5)	120 (0.5)	

Cooling system designed to operate in ambient conditions up to 50°C (122°F). Contact your local FG Wilson Dealer for power ratings at specific site conditions.

Lubrication System	
Oil Filter Type:	Spin-On, Full Flow
Total Oil Capacity: l (US gal)	8.3 (2.2)
Oil Pan: l (US gal)	7.8 (2.1)
Oil Type:	API CG4 / CH4 15W-40
Oil Cooling Method:	Water

Exhaust System	50 Hz	60 Hz
Silencer Type:	Industrial	
Silencer Model & Quantity:	SD80 (1)	
Pressure Drop Across Silencer System: kPa (in Hg)		
	0.98 (0.289)	1.22 (0.360)
Silencer Noise Reduction Level: dB	19	18
Maximum Allowable Back Pressure: kPa (in Hg)		
	10.0 (3.0)	15.0 (4.4)
Exhaust Gas Flow: m ³ /min (cfm)		
- Prime	10.1 (357)	11.8 (417)
- Standby	10.4 (367)	12.5 (441)
Exhaust Gas Temperature: °C (°F)		
- Prime	557 (1035)	534 (993)
- Standby	571 (1060)	564 (1047)

Alternator Physical Data	
Manufactured for FG Wilson by:	Leroy Somer
Model:	LL2014J
No. of Bearings:	1
Insulation Class:	H
Winding Pitch Code:	2/3 - 6
Wires:	12
Ingress Protection Rating:	IP23
Excitation System:	SHUNT
AVR Model:	R250

Alternator Operating Data	
Overspeed: rpm	2250
Voltage Regulation: (Steady state)	+/- 0.5
Wave Form NEMA = TIF:	50
Wave Form IEC = THF:	2.0%
Total Harmonic content LL/LN:	4.0%
Radio Interference:	Suppression is in line with European Standard EN61000-6
Radiant Heat: kW (Btu/min)	
- 50 Hz	9.4 (535)
- 60 Hz	11.9 (677)

Alternator Performance Data:	50 Hz			60 Hz	
	240V	230V	220V	220V/110V	240V/120V
Motor Starting Capability* kVA	162	153	144	127	143
Short Circuit Capacity** %	-	-	-	-	-
Reactances: Per Unit					
Xd	1.734	1.888	2.064	2.697	2.313
X'd	0.105	0.114	0.125	0.163	0.140
X''d	0.053	0.058	0.063	0.083	0.071

Reactances shown are applicable to prime ratings.
 *Based on 30% voltage dip at 0.9 power factor.
 **With optional permanent magnet generator or AREP excitation.

Voltage Technical Data 50 Hz				
Voltage	Prime:		Standby:	
	kVA	kW	kVA	kW
240V	45.0	45.0	50.0	50.0
230V	45.0	45.0	50.0	50.0
220V	45.0	45.0	49.7	49.7

Voltage Technical Data 60 Hz				
Voltage	Prime:		Standby:	
	kVA	kW	kVA	kW
220V/110V	49.0	49.0	53.9	53.9
240V/120V	50.0	50.0	55.0	55.0

Documentation

A full set of operation and maintenance manuals and circuit wiring diagrams.

Generating Set Standards

The equipment meets the following standards: BS5000, ISO 8528, ISO 3046, IEC 60034, NEMA MG-1.22.

FG Wilson is a fully accredited ISO 9001 company.

Warranty

All prime equipment carries a one year manufacturer's warranty. Standby equipment, limited to 500 running hours per year, has a two year manufacturer's warranty. For details on warranty cover please contact your local Dealer, or visit our website: FGWilson.com.

Dealer contact details:

FG Wilson has manufacturing facilities in the following locations:

Northern Ireland • Brazil • China • India • USA

With headquarters in Northern Ireland, FG Wilson operates through a Global Dealer Network.

To contact your local Sales Office please visit the FG Wilson website at www.FGWilson.com